

GPT.05.232.15000/B
Revision: 00

Suzuki SV650 / SV1000 ab Bj. 03

ALU-RACK Montagehinweise

Alle vom Motorrad gelösten Schrauben sind gemäß Herstellerangaben wieder zu montieren, oder mit von SW-MOTECH gelieferten Schrauben zu ersetzen. Falls nicht anderweitig definiert, diese Schrauben nach Tabelle anziehen.

M6	9,6 Nm
M8	23 Nm
M10	46 Nm

Gegebenenfalls Schrauben mit flüssiger Schraubensicherung einkleben.

Prüfen Sie nach 50 km alle Verbindungen auf festen Sitz.

Max. Zuladung 7,5 Kg inklusive Koffer und Adapter. Ist das Zuladungsgewicht des Fahrzeuges durch den Hersteller limitiert, gelten diese Grenzwerte.

SW-MOTECH GmbH & Co. KG
Ernteweg 7-10
35282 Rauschenberg
Germany

Tel. +49 (0) 64 25/8 16 8-050
Fax +49 (0) 64 25/8 16 8-10

info@sw-motech.com
www.sw-motech.com



ALU-RACK Mounting Instructions

SW-MOTECH products should be installed by a qualified, experienced motorcycle technician. If you are unsure of your ability to properly install a product, please have the product installed by your local motorcycle dealer. SW-MOTECH takes no responsibility for damages caused by improper installation.

All screws, bolts and nuts, including all replacement hardware provided by SW-MOTECH, should be tightened to the torque specified in the OEM maintenance manual for your motorcycle. If no torque specifications are provided in the OEM maintenance manual, the following torques may be used:

M6	9,6 Nm
M8	23 Nm
M10	46 Nm

All screws, bolts and nuts should be checked after driving the first 50 km to ensure that all are tightened to the proper torque.

Medium strength liquid thread-locker (i.e., "Loctite") should be used to secure all screws, bolts, and nuts.

Max. Load On Rear Carrier: 7,5 Kg (16,5 lbs) inclusive case and adapter or the motorcycle manufacturer's weight limit, whichever is less.

1 Anbaublech
Mounting Bracket



GPT.05.232.003L/R
Anzahl/Pcs. 2 (L/R)

2 Distanzbuchse
Spacer

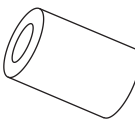

Ø 15 / ø 6,2 / h 24,5
Anzahl/Pcs. 2

3 Innensechskantschraube
Hexagon Socket Screw



silber/silver
M6 x 40 DIN 912
Anzahl/Pcs. 2

4 Unterlegscheibe
Washer



silber/silver
ø 6,4 DIN 125
Anzahl/Pcs. 2

5 Mutter mit Bund
Nut



silber/silver
M6 DIN 6927
Anzahl/Pcs. 2

6 Anbaublech
Mounting Bracket

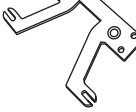

GPT.05.232.900.01
Anzahl/Pcs. 1

7 Formscheibe
Moulding

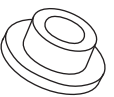

GPT.05.232.004.01
Anzahl/Pcs. 2

8 Linsenkopfschraube
Lenshead Screw

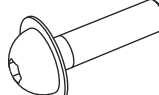

schwarz/black
M8 x 40 ISO 7380
Anzahl/Pcs. 2

9 Linsenkopfschraube
Lenshead Screw

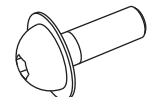

schwarz/black
M6 x 20 ISO 7380
Anzahl/Pcs. 2

10 Mutter mit Bund
Nut



schwarz/black
M6 DIN 6927
Anzahl/Pcs. 2

11 Gepäckträger
Luggage Carrier

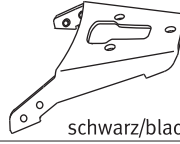

schwarz/black
GPT.00.232.030
Anzahl/Pcs. 1

12 Linsenkopfschraube
Lenshead Screw

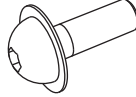

schwarz/black
M8 x 16 ISO 7380
Anzahl/Pcs. 4

13 Anbaublech
Mounting Bracket

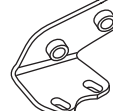

GPT.05.232.008L/R
Anzahl/Pcs. 2(L/R)

14 Senkkopfschraube
Countersunk Screw



schwarz/black
M8 x 25 DIN 7991
Anzahl/Pcs. 4

15 Senkscheibe
Countersunk Washer



schwarz/black
ø 8,4
Anzahl/Pcs. 4

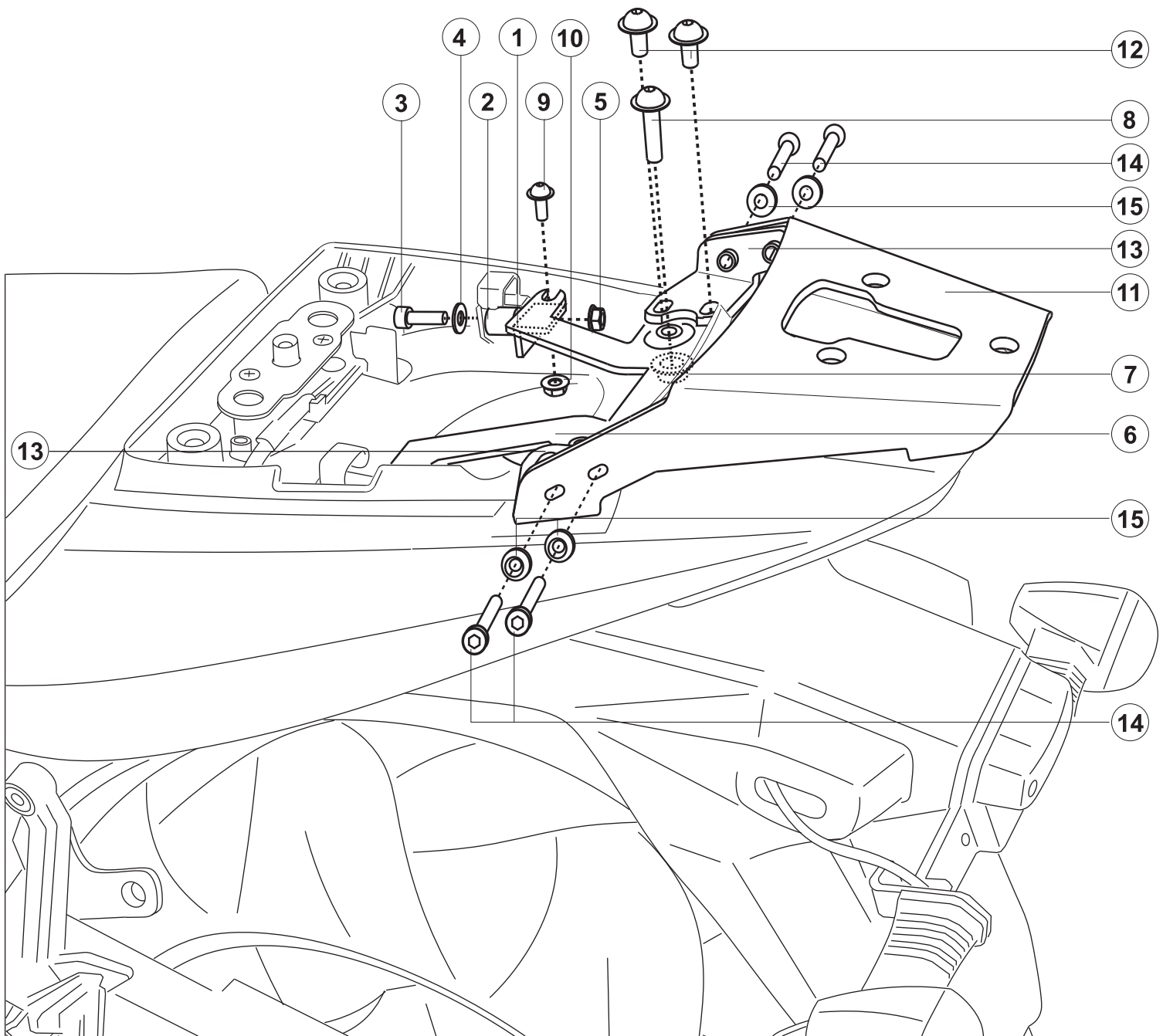

! Achtung: Falls die Montage einer Adapterplatte vorgesehen ist, **MÜSSEN** die Haltenocken am Alu-Rack vor dessen Anbau am Motorrad verschraubt werden.

Attention: Cam-locks from adapter kit **MUST** be installed before attaching the alu-rack to the bike.